

Link do produktu: <http://poltech24.pl/shf-50-wspornik-koncowy-walka-liniowego-cnc-p-319.html>



SHF 50 Wspornik końcowy wałka liniowego CNC

Cena brutto **75,00 zł**

Cena netto **60,98 zł**

Dostępność **Dostępny**

Numer katalogowy **SHF50**

Symbol **SHF50**

Opis produktu

Wspornik końcowy wałka typu SHF50 na wałek fi 50 mm



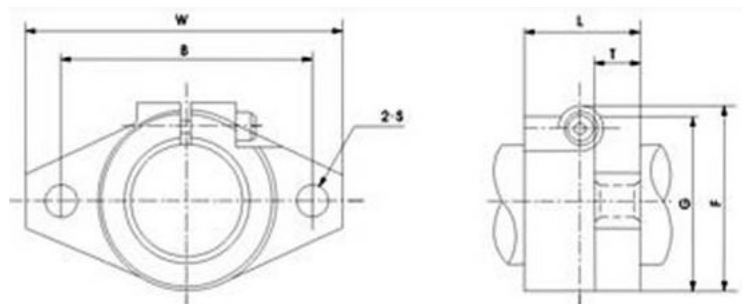

Nazwa	Walek	Wymiary [mm]								Śruba Zaciskowa	Śruba Montażowa	Waga [kg]
		W	L	T	F	G	B	S				
SHF08	8	43	10	5	24	20	32	5.5	M4	M5	0.013	
SHF10	10	43	10	5	24	20	32	5.5	M4	M5	0.013	
SHF12	12	47	13	7	28	25	36	5.5	M4	M5	0.020	
SHF13	13	47	13	7	28	25	36	5.5	M4	M5	0.020	
SHF16	16	50	16	8	31	28	40	5.5	M4	M5	0.027	
SHF20	20	60	20	8	37	34	48	7	M5	M6	0.040	
SHF25	25	70	25	10	42	40	56	7	M5	M6	0.060	
SHF30	30	80	30	12	50	46	64	9	M6	M8	0.110	
SHF35	35	92	35	14	58	50	72	12	M8	M10	0.380	
SHF40	40	102	40	16	67	56	80	12	M10	M10	0.510	
SHF50	50	122	50	19	83	70	96	14	M12	M12	0.890	
SHF60	60	140	60	23	95	82	112	14	M12	M12	1.500	